

L70
25°C

200,000 Hours



ASTA

LED SPORTS LIGHTS



FULL-CUTOFF

Designed for sports lighting, ASTA's full-cutoff optics and 3000K LEDs deliver precise, glare-controlled illumination that enhances visibility for both players and spectators while supporting compliance with DarkSky International standards and IES guidelines.

PRODUCT DESCRIPTION

ASTA LED Sports Lights are engineered with advanced thermal management and high-efficiency optics to deliver powerful, uniform illumination with exceptional control — minimizing glare and maximizing visibility across courts, fields, and recreational spaces. Built for harsh environments, ASTA combines durability, efficiency, and optical precision to provide a professional-grade lighting solution that enhances both play and spectator experience.

DURABLE AND RELIABLE

Constructed from corrosion-resistant materials with IP66, IK10 impact protection, and 1,000-hour salt spray rating, ASTA is built to withstand harsh environments and extreme weather conditions.

EXTREME-LIFE

Engineered with superior heat sink designs, ASTA delivers an industry-leading L70 rating of up to 200,000 hours, ensuring decades of reliable, maintenance-free operation.



SPECIFICATION FEATURES

WATTAGES	40w, 60w, 80w, 120w, 180w, 160w, 240w, 320w, 360w, 480w, 720w, 960w, 1440w, 1920w, 2400w,
EFFICIENCY	Up to 160 LPW
KELVIN TEMPERATURES	2200K, 3000K, 4000K, 5000K, 5700K
MOUNTING	T Mount (Arm Mount) L Mount (SlipFitter Mount) U Mount (Bracket Mount)
HOUSING COLORS	Black, Bronze, Gray, White Green, Custom RAL
HOUSING FINISH	Super Durable and Corrosion resistant Polyester Powder Paint.
CONSTRUCTION	Premium Die-Cast Aluminum
OPTICS	T2S, T3S, T3M, T4VVS, T4VS, T4S, T4M, T10D, T20D, T40D, T60D, T90D, T5M
CRI	70+, 80+, 90+
VOLTAGE	100-277V, 277-480V
OPERATING TEMPERATURE	-40°C~+50°C
SURGE PROTECTION	10KA, 20KA
CONTROLS and ADD-Ons	0-10V Dimming, 1-10V Dimming, Vandal Resistant Screws, Power Cords, Safety Cables, Microwave Motion Sensor, Photocell, Backlight Shield, Bird Spikes, Emergency Power Supply
CERTIFICATIONS	<ul style="list-style-type: none"> ·cULus Listed ·CE-LVD/CE-EMC/CB ·SAA ·DLC Premium qualified versions available ·RoHS compliant ·Endurance tested to withstand 5,000H of elevated ambient salt fog conditions as defined in ASTM Standard B117 · 10KA surge suppression protection tested in accordance with IEEE/ANSI C62.41.2 ·Certified to ANSI C136.31-2010, 3G bridge and overpass vibration standards
WARRANTY	5 Year Warranty, 10 Year Warranty

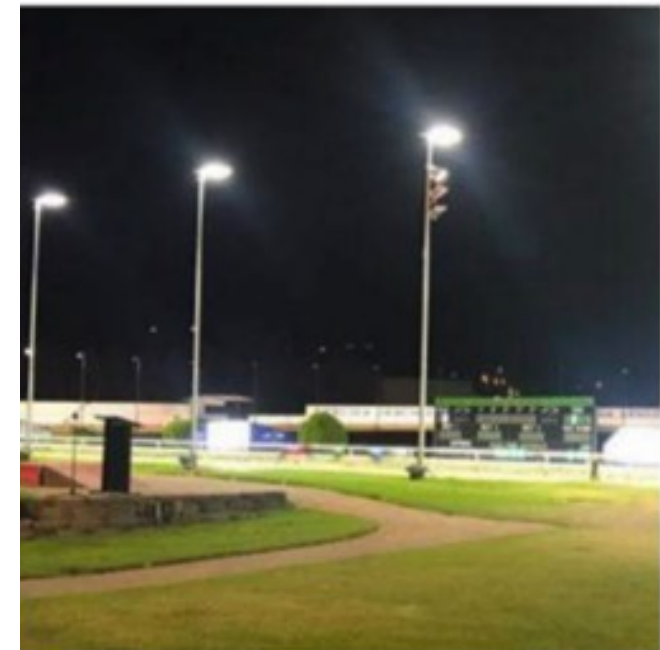

SCREWLESS DESIGN LENS



NO SCREW ON THE LENS

IP68 Waterproof
Better corrosion resistance IK10 Level
Impact Resistance

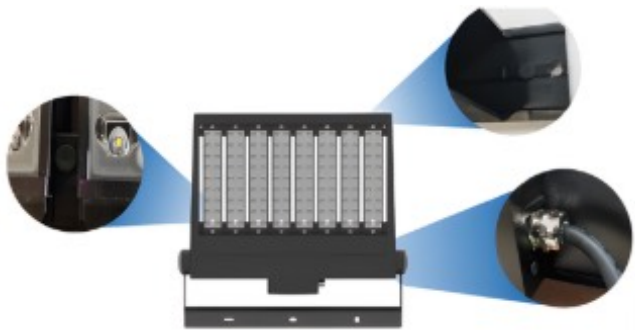

ANTI-CORROSION TEST STANDARD ASTM-B117

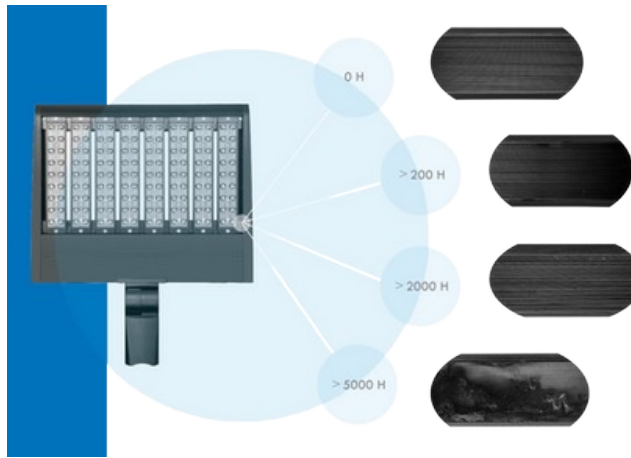

UPGRADED HEAT SINK

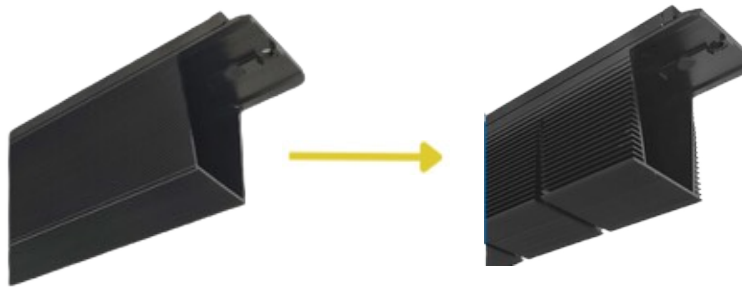

Air Tight Test at 30KPa
100% test via the test points on
each LED Module, supporting frame
and junction box.

HEAT SINKS

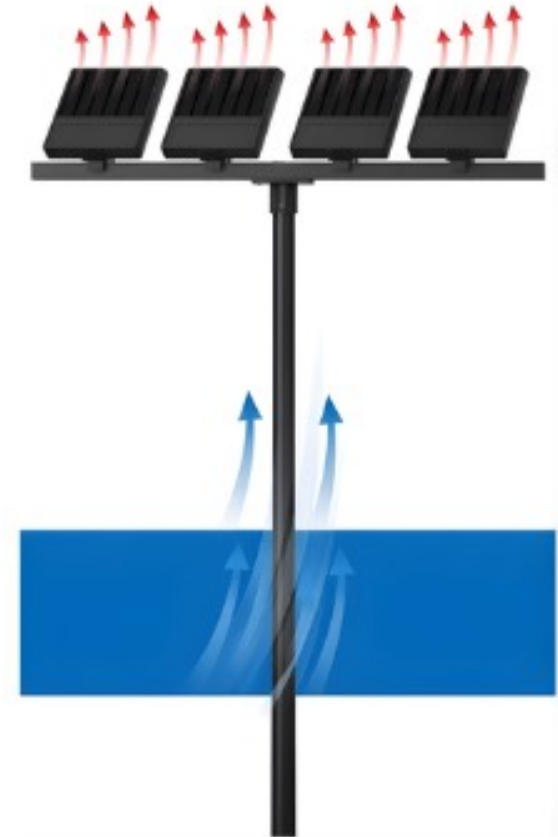

SPILL CONTROL

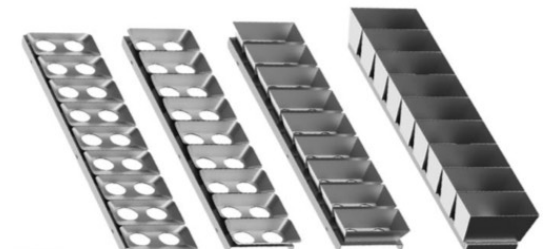

LIGHT DISTRIBUTION

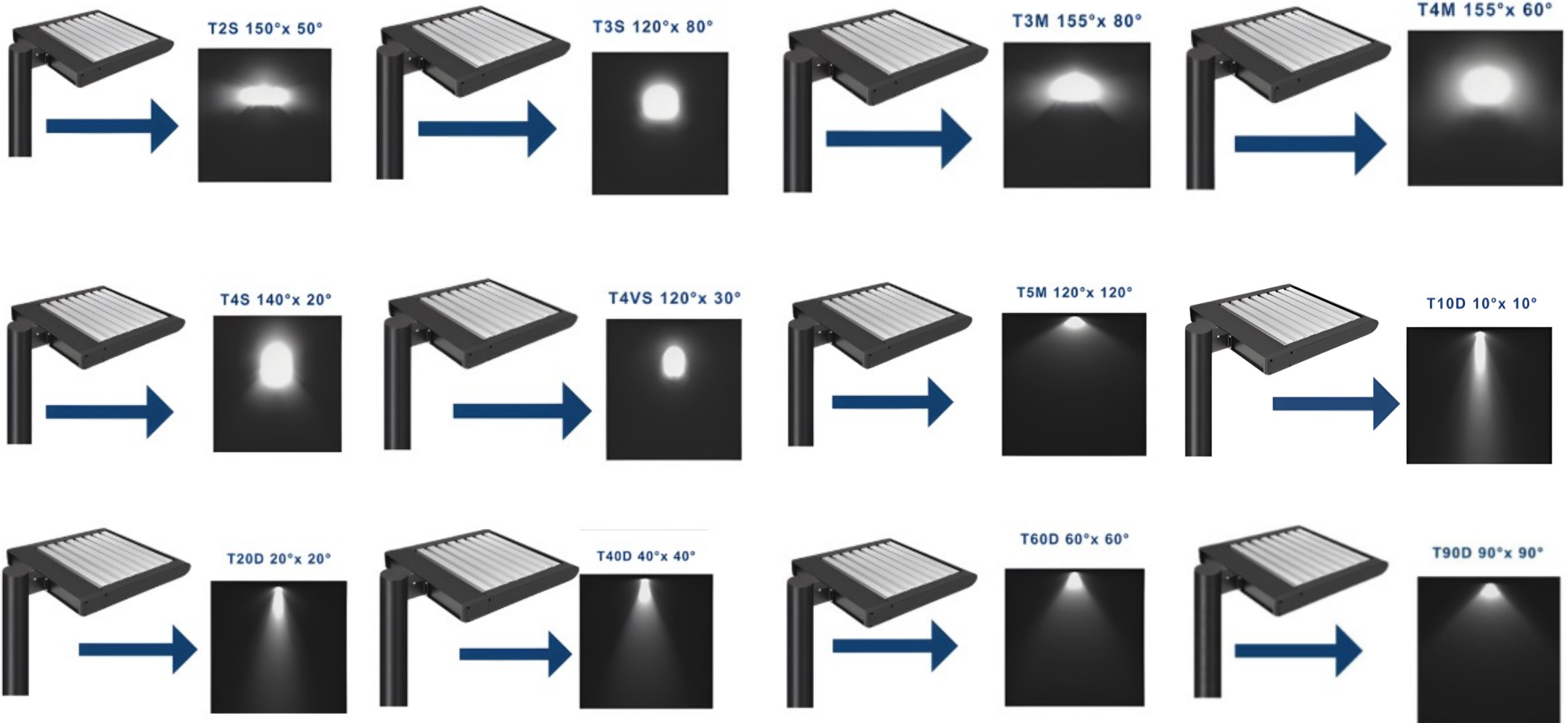

PHOTOMETRY

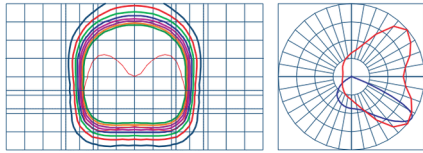

T3S Type III short

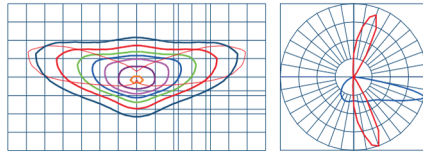

T3M Type III medium

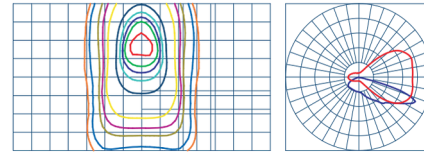

T4VS Type IV very short

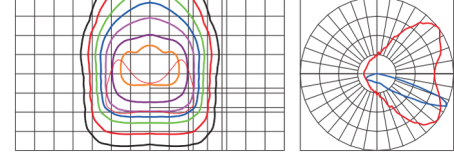

T4S Type IV Short

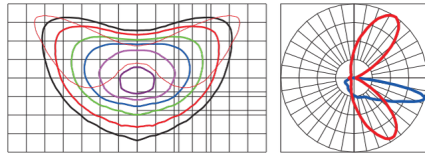

T4M Type IV Medium

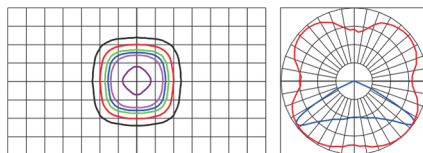

T5M Type V Square Medium

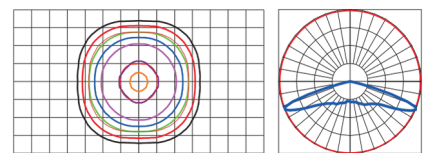

T5W Type V Square Wide

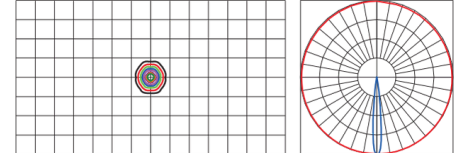

T10D 10° Flood

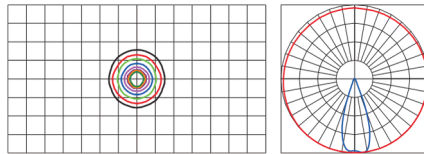

T40D 40° Flood

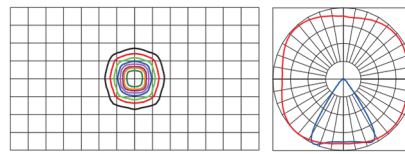

T60D 60° Flood

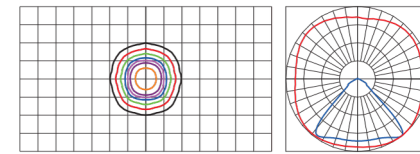

T90D 90° Flood



OPTIC ORIENTATION

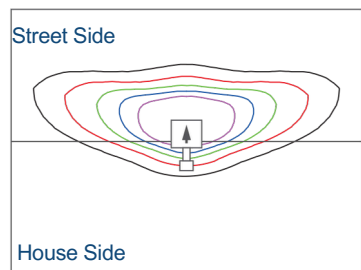

Standard

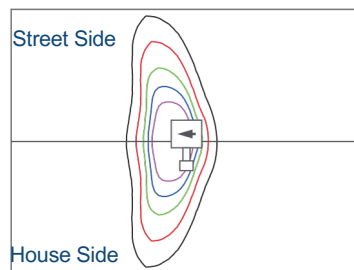

Optics Rotated Left@90°

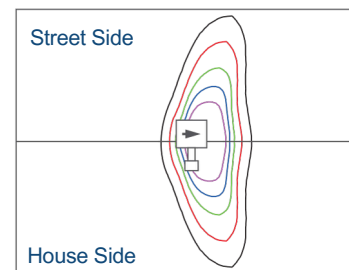

Optics Rotated Right @ 90°

OPTICAL DISTRIBUTIONS

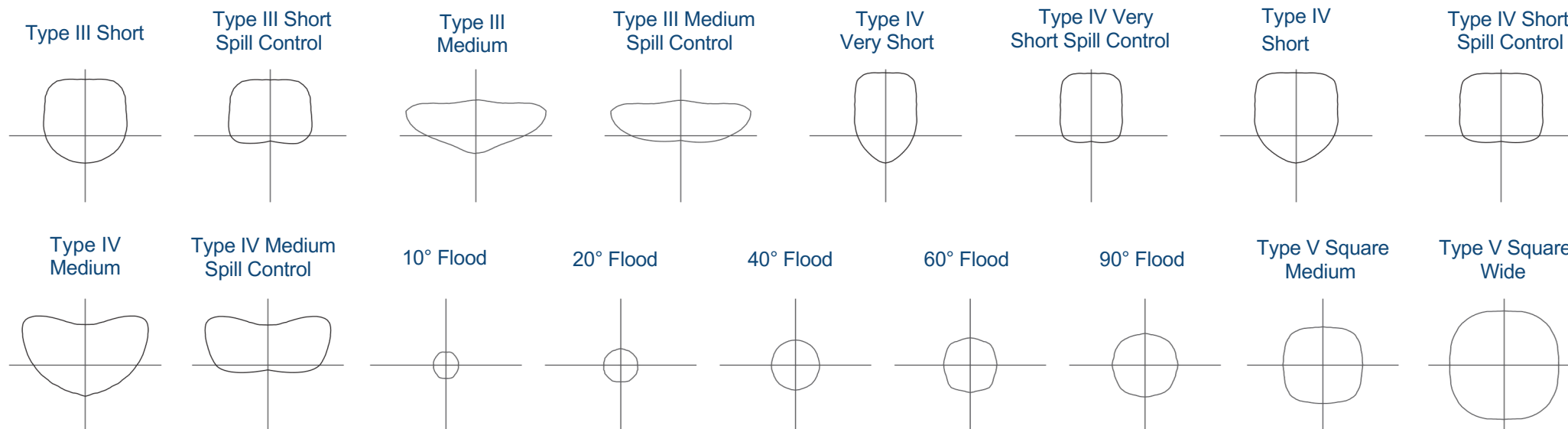

ORDERING INFORMATION

MODEL	VOLTAGE	MOUNTING	OPTIC	CCT	COLOR FINISH	OPTIONS
AF88XPAC40	100-277v	L Mount (SlipFitter Mount)	T2S	2700K	Black	1-10V Dimming
AF88XPAC80	277-480v	T Mount (Fixed Arm Mount)	T3S	3000K	Bronze	Vandal Resistant Screws
AF88XPAC120		U Mount (Bracket Mount)	T3M	4000K	Gray	Power Cords
AF88XPAC160			T5M	5000K	White	Safety Cables
AF88XPAC200			T4M	5700K	Green	Microwave Motion Sensor
AF88XPAC240			T4S		Custom RAL	Photocell
AF88XPAC320			T4VS			Backlight Shield
AF88XPAD60			T4VVS			Bird Spikes
AF88XPAD120			T10D			Emergency PowerSupply
AF88XPAD180			T20D			
AF88XPAD240			T40D			
AF88XPAD300			T60D			
AF88XPAD360			T90D			
AF88XPAD480						
AF88XPBD720						
AF88XPBD960						
AF88XPBE960						
AF88XPBE1440						

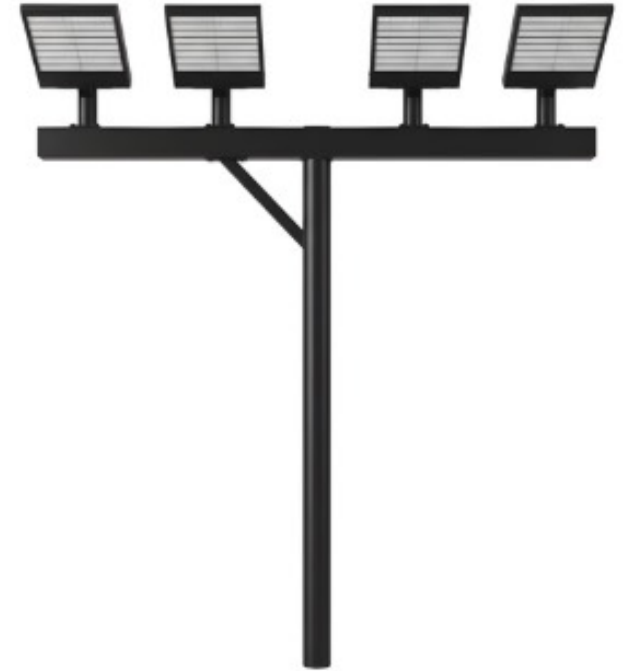

L Mount
Slip Fitter Mount



800-468-9925

T Mount
Fixed Arm Mount

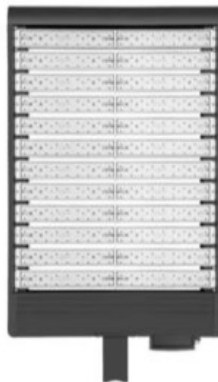

Sales@AccessFixtures.com

U Mount
Bracket Mount



www.AccessFixtures.com

AREA LIGHT BRIEF SPECIFICATIONS

Model	Nominal power	LED current	Module number	Module power	Product size LWH (mm/in)	Packing size LWH (mm/in)	Net weight	Gross weight	Typical luminous flux(lm)	Typical efficiency (lm/W)
AF88XPAC40L	40W	700mA	1	40W	455(17.91)*334(13.15)*75(2.95)	505(19.88)*425(16.73)*160(6.30)	5.2KG	6.1KG	6080	152
AF88XPAC80L	80W	700mA	2	40W	517(20.35)*334(13.15)*75(2.95)	567(22.32)*425(16.73)*160(6.30)	6.1KG	7.1KG	12160	152
AF88XPAC120L	120W	700mA	3	40W	580(22.83)*334(13.15)*75(2.95)	630(24.80)*425(16.73)*160(6.30)	7.0KG	8.0KG	18360	153
AF88XPAC160L	160W	700mA	4	40W	642(25.28)*334(13.15)*75(2.95)	692(27.24)*425(16.73)*160(6.30)	7.6KG	8.7KG	24960	156
AF88XPAC200L	200W	700mA	5	40W	705(27.76)*334(13.15)*75(2.95)	755(29.72)*425(16.73)*160(6.30)	8.5KG	9.8KG	30800	154
AF88XPAC240L	240W	700mA	6	40W	767(30.20)*334(13.15)*75(2.95)	817(32.17)*425(16.73)*160(6.30)	9.2KG	10.4KG	36960	154
AF88XPAC320L	320W	700mA	8	40W	892(35.12)*334(13.15)*75(2.95)	943(37.13)*425(16.73)*160(6.30)	11.1KG	12.5KG	49920	156
AF88XPAD60L	60W	1050mA	1	60W	455(17.91)*334(13.15)*75(2.95)	505(19.88)*425(16.73)*160(6.30)	5.3KG	6.2KG	8340	139
AF88XPAD120L	120W	1050mA	2	60W	517(20.35)*334(13.15)*75(2.95)	567(22.32)*425(16.73)*160(6.30)	6.2KG	7.2KG	16560	138
AF88XPAD180L	180W	1050mA	3	60W	580(22.83)*334(13.15)*75(2.95)	630(24.80)*425(16.73)*160(6.30)	7.2KG	8.2KG	25200	140
AF88XPAD240L	240W	1050mA	4	60W	642(25.38)*334(13.15)*75(2.95)	692(27.24)*425(16.73)*160(6.30)	7.8KG	8.9KG	34080	142
AF88XPAD300L	300W	1050mA	5	60W	705(27.76)*334(13.15)*75(2.95)	755(29.72)*425(16.73)*160(6.30)	9.2KG	10.5KG	42600	142
AF88XPAD360L	360W	1050mA	6	60W	767(30.20)*334(13.15)*75(2.95)	817(32.17)*425(16.73)*160(6.30)	9.9KG	11.1KG	50040	139
AF88XPAD480L	480W	1050mA	8	60W	892(35.12)*334(13.15)*75(2.95)	943(37.13)*425(16.73)*160(6.30)	11.4KG	12.8KG	67200	140
AF88XPBD720L	720W	1050mA	6	120W	767(30.20)*608(23.94)*75(2.95)	823(32.40)*700(27.56)*160(6.30)	15.7KG	18.1KG	100080	139
AF88XPBD960L	960W	1050mA	8	120W	892(35.12)*608(23.94)*75(2.95)	948(37.32)*700(27.56)*160(6.30)	17.7KG	20.1KG	133440	139
AF88XPBE960L	960W	1400mA	6	160W	767(27.76)*608(23.94)*75(2.95)	823(32.40)*700(27.56)*160(6.30)	14.5KG	16.5KG	122880	128
AF88XPBE1440	1440W	1400mA	9	160W	955(37.60)*608(23.94)*75(2.95)	1011(39.80)*700(27.56)*160(6.30)	19.7KG	21.8KG	184320	128
277v-480v										
AF88XPAC40L	40W	700mA	1	40W	455(17.91)*334(13.15)*75(2.95)	505(19.88)*425(16.73)*160(6.30)	5.2KG	6.1KG	6080	152
AF88XPAC80L	80W	700mA	2	40W	517(20.35)*334(13.15)*75(2.95)	567(22.32)*425(16.73)*160(6.30)	6.1KG	7.1KG	12160	152
AF88XPAC120L	120W	700mA	3	40W	580(22.83)*334(13.15)*75(2.95)	630(24.80)*425(16.73)*160(6.30)	7.0KG	8.0KG	18360	153
AF88XPAC160L	160W	700mA	4	40W	642(25.28)*334(13.15)*75(2.95)	692(27.24)*425(16.73)*160(6.30)	7.6KG	8.7KG	24960	156
AF88XPAC200L	200W	700mA	5	40W	705(27.76)*334(13.15)*75(2.95)	755(29.72)*425(16.73)*160(6.30)	8.5KG	9.8KG	30800	154
AF88XPAC240L	240W	700mA	6	40W	767(30.20)*334(13.15)*75(2.95)	817(32.17)*425(16.73)*160(6.30)	9.2KG	10.4KG	36960	154
AF88XPAC320L	320W	700mA	8	40W	892(35.12)*334(13.15)*75(2.95)	943(37.13)*425(16.73)*160(6.30)	11.1KG	12.5KG	49920	156
AF88XPAD60L	60W	1050mA	1	60W	455(17.91)*334(13.15)*75(2.95)	505(19.88)*425(16.73)*160(6.30)	5.3KG	6.2KG	8340	139
AF88XPAD120L	120W	1050mA	2	60W	517(20.35)*334(13.15)*75(2.95)	567(22.32)*425(16.73)*160(6.30)	6.2KG	7.2KG	16560	138
AF88XPAD180L	180W	1050mA	3	60W	580(22.83)*334(13.15)*75(2.95)	630(24.80)*425(16.73)*160(6.30)	7.2KG	8.2KG	25200	140
AF88XPAD240L	240W	1050mA	4	60W	642(25.38)*334(13.15)*75(2.95)	692(27.24)*425(16.73)*160(6.30)	7.8KG	8.9KG	34080	142
AF88XPAD300L	300W	1050mA	5	60W	705(27.76)*334(13.15)*75(2.95)	755(29.72)*425(16.73)*160(6.30)	9.2KG	10.5KG	42600	142
AF88XPAD360L	360W	1050mA	6	60W	767(30.20)*334(13.15)*75(2.95)	817(32.17)*425(16.73)*160(6.30)	9.9KG	11.1KG	50040	139
AF88XPAD480L	480W	1050mA	8	60W	892(35.12)*334(13.15)*75(2.95)	943(37.13)*425(16.73)*160(6.30)	11.4KG	12.8KG	67200	140
AF88XPBD720L	720W	1050mA	6	120W	767(30.20)*608(23.94)*75(2.95)	823(32.40)*700(27.56)*160(6.30)	15.7KG	18.1KG	100080	139
AF88XPBD960L	960W	1050mA	8	120W	892(35.12)*608(23.94)*75(2.95)	948(37.32)*700(27.56)*160(6.30)	17.7KG	20.1KG	133440	139
AF88XPBE960L	960W	1400mA	6	160W	767(27.76)*608(23.94)*75(2.95)	823(32.40)*700(27.56)*160(6.30)	14.5KG	16.5KG	122880	128
AF88XPBE1440	1440W	1400mA	9	160W	955(37.60)*608(23.94)*75(2.95)	1011(39.80)*700(27.56)*160(6.30)	19.7KG	21.8KG	184320	128

FLOOD LIGHT BRIEF SPECIFICATIONS

Model	Nominal power	LED current	Module number	Module power	Product size LWH (mm/in)	Packing size LWH (mm/in)	Net weight	Gross weight	Typical luminous flux(lm)	Typical efficiency (lm/W)
AF88XPAC40L	40W	700mA	1	40W	455(17.91)*334(13.15)*75(2.95)	505(19.88)*425(16.73)*160(6.30)	5.2KG	6.1KG	6080	152
AF88XPAC80L	80W	700mA	2	40W	517(20.35)*334(13.15)*75(2.95)	567(22.32)*425(16.73)*160(6.30)	6.1KG	7.1KG	12160	152
AF88XPAC120L	120W	700mA	3	40W	580(22.83)*334(13.15)*75(2.95)	630(24.80)*425(16.73)*160(6.30)	7.0KG	8.0KG	18360	153
AF88XPAC160L	160W	700mA	4	40W	642(25.28)*334(13.15)*75(2.95)	692(27.24)*425(16.73)*160(6.30)	7.6KG	8.7KG	24960	156
AF88XPAC200L	200W	700mA	5	40W	705(27.76)*334(13.15)*75(2.95)	755(29.72)*425(16.73)*160(6.30)	8.5KG	9.8KG	30800	154
AF88XPAC240L	240W	700mA	6	40W	767(30.20)*334(13.15)*75(2.95)	817(32.17)*425(16.73)*160(6.30)	9.2KG	10.4KG	36960	154
AF88XPAC320L	320W	700mA	8	40W	892(35.12)*334(13.15)*75(2.95)	943(37.13)*425(16.73)*160(6.30)	11.1KG	12.5KG	49920	156
AF88XPAD60L	60W	1050mA	1	60W	455(17.91)*334(13.15)*75(2.95)	505(19.88)*425(16.73)*160(6.30)	5.3KG	6.2KG	8340	139
AF88XPAD120L	120W	1050mA	2	60W	517(20.35)*334(13.15)*75(2.95)	567(22.32)*425(16.73)*160(6.30)	6.2KG	7.2KG	16560	138
AF88XPAD180L	180W	1050mA	3	60W	580(22.83)*334(13.15)*75(2.95)	630(24.80)*425(16.73)*160(6.30)	7.2KG	8.2KG	25200	140
AF88XPAD240L	240W	1050mA	4	60W	642(25.38)*334(13.15)*75(2.95)	692(27.24)*425(16.73)*160(6.30)	7.8KG	8.9KG	34080	142
AF88XPAD300L	300W	1050mA	5	60W	705(27.76)*334(13.15)*75(2.95)	755(29.72)*425(16.73)*160(6.30)	9.2KG	10.5KG	42600	142
AF88XPAD360L	360W	1050mA	6	60W	767(30.20)*334(13.15)*75(2.95)	817(32.17)*425(16.73)*160(6.30)	9.9KG	11.1KG	50040	139
AF88XPAD480L	480W	1050mA	8	60W	892(35.12)*334(13.15)*75(2.95)	943(37.13)*425(16.73)*160(6.30)	11.4KG	12.8KG	67200	140
AF88XPBD720L	720W	1050mA	6	120W	767(30.20)*608(23.94)*75(2.95)	823(32.40)*700(27.56)*160(6.30)	15.7KG	18.1KG	100080	139
AF88XPBD960L	960W	1050mA	8	120W	892(35.12)*608(23.94)*75(2.95)	948(37.32)*700(27.56)*160(6.30)	17.7KG	20.1KG	133440	139
AF88XPBE960L	960W	1400mA	6	160W	767(27.76)*608(23.94)*75(2.95)	823(32.40)*700(27.56)*160(6.30)	14.5KG	16.5KG	122880	128
AF88XPBE1440	1440W	1400mA	9	160W	955(37.60)*608(23.94)*75(2.95)	1011(39.80)*700(27.56)*160(6.30)	19.7KG	21.8KG	184320	128
277v-480v										
AF88XPAC40L	40W	700mA	1	40W	455(17.91)*334(13.15)*75(2.95)	505(19.88)*425(16.73)*160(6.30)	5.2KG	6.1KG	6080	152
AF88XPAC80L	80W	700mA	2	40W	517(20.35)*334(13.15)*75(2.95)	567(22.32)*425(16.73)*160(6.30)	6.1KG	7.1KG	12160	152
AF88XPAC120L	120W	700mA	3	40W	580(22.83)*334(13.15)*75(2.95)	630(24.80)*425(16.73)*160(6.30)	7.0KG	8.0KG	18360	153
AF88XPAC160L	160W	700mA	4	40W	642(25.28)*334(13.15)*75(2.95)	692(27.24)*425(16.73)*160(6.30)	7.6KG	8.7KG	24960	156
AF88XPAC200L	200W	700mA	5	40W	705(27.76)*334(13.15)*75(2.95)	755(29.72)*425(16.73)*160(6.30)	8.5KG	9.8KG	30800	154
AF88XPAC240L	240W	700mA	6	40W	767(30.20)*334(13.15)*75(2.95)	817(32.17)*425(16.73)*160(6.30)	9.2KG	10.4KG	36960	154
AF88XPAC320L	320W	700mA	8	40W	892(35.12)*334(13.15)*75(2.95)	943(37.13)*425(16.73)*160(6.30)	11.1KG	12.5KG	49920	156
AF88XPAD60L	60W	1050mA	1	60W	455(17.91)*334(13.15)*75(2.95)	505(19.88)*425(16.73)*160(6.30)	5.3KG	6.2KG	8340	139
AF88XPAD120L	120W	1050mA	2	60W	517(20.35)*334(13.15)*75(2.95)	567(22.32)*425(16.73)*160(6.30)	6.2KG	7.2KG	16560	138
AF88XPAD180L	180W	1050mA	3	60W	580(22.83)*334(13.15)*75(2.95)	630(24.80)*425(16.73)*160(6.30)	7.2KG	8.2KG	25200	140
AF88XPAD240L	240W	1050mA	4	60W	642(25.38)*334(13.15)*75(2.95)	692(27.24)*425(16.73)*160(6.30)	7.8KG	8.9KG	34080	142
AF88XPAD300L	300W	1050mA	5	60W	705(27.76)*334(13.15)*75(2.95)	755(29.72)*425(16.73)*160(6.30)	9.2KG	10.5KG	42600	142
AF88XPAD360L	360W	1050mA	6	60W	767(30.20)*334(13.15)*75(2.95)	817(32.17)*425(16.73)*160(6.30)	9.9KG	11.1KG	50040	139
AF88XPAD480L	480W	1050mA	8	60W	892(35.12)*334(13.15)*75(2.95)	943(37.13)*425(16.73)*160(6.30)	11.4KG	12.8KG	67200	140
AF88XPBD720L	720W	1050mA	6	120W	767(30.20)*608(23.94)*75(2.95)	823(32.40)*700(27.56)*160(6.30)	15.7KG	18.1KG	100080	139
AF88XPBD960L	960W	1050mA	8	120W	892(35.12)*608(23.94)*75(2.95)	948(37.32)*700(27.56)*160(6.30)	17.7KG	20.1KG	133440	139
AF88XPBE960L	960W	1400mA	6	160W	767(27.76)*608(23.94)*75(2.95)	823(32.40)*700(27.56)*160(6.30)	14.5KG	16.5KG	122880	128
AF88XPBE1440	1440W	1400mA	9	160W	955(37.60)*608(23.94)*75(2.95)	1011(39.80)*700(27.56)*160(6.30)	19.7KG	21.8KG	184320	128

LUMINAIRE EPA

ARM MOUNT











	40-60W	80-120W	120-180W	160-240W	200-300W	240-360W	320-480W	720W	960W
									
	0.32	0.36	0.41	0.45	0.50	0.55	0.65	0.60	0.69

SLIP-FITTER MOUNT



	0°Tilt	10°Tilt	20°Tilt	30°Tilt	45°Tilt	60°Tilt	70°Tilt	80°Tilt	90°Tilt
									
40-60W	0.36	0.44	0.50	0.58	0.66	0.73	0.81	0.87	0.95
80-120W	0.41	0.51	0.60	0.70	0.80	0.89	0.99	1.08	1.18
120-180W	0.46	0.58	0.70	0.82	0.94	1.05	1.17	1.29	1.41
160-240W	0.51	0.65	0.79	0.93	1.07	1.21	1.35	1.49	1.63
200-300W	0.56	0.72	0.89	1.05	1.21	1.37	1.54	1.70	1.86
240-360W	0.60	0.79	0.97	1.16	1.34	1.53	1.71	1.90	2.08
320-480W	0.70	0.93	1.16	1.39	1.62	1.84	2.07	2.30	2.53
720W	0.65	1.03	1.41	1.79	2.17	2.54	2.92	3.30	3.68
960W	0.74	1.22	1.70	2.17	2.65	3.13	3.61	4.08	4.56

U-BRACKET MOUNT

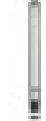
	0° Tilt	10° Tilt	20° Tilt	30° Tilt	45° Tilt	60° Tilt	70° Tilt	80° Tilt	90° Tilt
									
40-60W	0.36	0.44	0.50	0.58	0.66	0.73	0.81	0.87	0.95
80-120W	0.42	0.51	0.60	0.68	0.77	0.86	0.95	1.03	1.12
120-180W	0.46	0.57	0.68	0.79	0.91	1.02	1.13	1.24	1.35
160-240W	0.50	0.63	0.77	0.90	1.04	1.17	1.30	1.44	1.57
200-300W	0.55	0.71	0.86	1.02	1.18	1.33	1.49	1.64	1.80
240-360W	0.59	0.77	0.95	1.13	1.31	1.48	1.66	1.84	2.02
320-480W	0.68	0.90	1.13	1.35	1.58	1.80	2.02	2.25	2.47
720-960W	0.74	1.11	1.48	1.85	2.22	2.59	2.96	3.33	3.70
960W	0.82	1.28	1.75	2.21	2.67	3.13	3.60	4.06	4.52
1440W	0.86	1.32	1.79	2.36	2.82	3.38	3.86	4.46	4.80
1920W	0.96	1.52	2.20	3.48	4.11	4.70	5.34	5.34	6.02
2400W	1.04	1.65	2.38	3.77	4.45	5.10	5.78	5.78	6.52

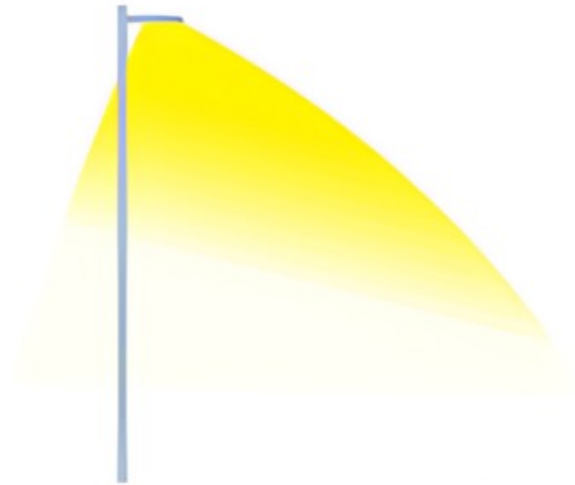

Without Backlight Shield



With Backlight Shield



T4VS

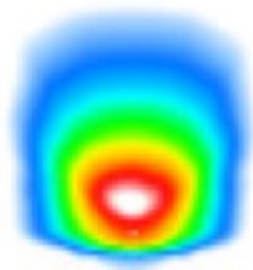

T4VS with Backlight shield



T4VVS



Certification	Standards	Remark
CE-LVD Low Voltage Directive (2014/35/EC)	EN 60598-2-3/A1:2011	Applicable for Street Light
	EN 60598-2-5:2015	Applicable for Flood Light
	EN 60598-1:2015/A1:2018	
	EN 62471:2008	
	EN 62493:2015	
CE-EMC Electromagnetic Compatibility Directive (2014/30/EU)	EN 55015:2013/A1:2015	
	EN 61547:2009	
	EN 61000-3-2:2014	
	EN 61000-3-3:2013	
CE-ErP Energy-Related Products Directive (2009/125/EU)	EU 1194/2012:2012-12-12	
	EC 244/2009:2009-03-18	
	EU 859/2009:2009-09-18	
CE-RoHS Directive (2011/65/EU)	EN 62321:2009	
CB	IEC 60598-2-3/A1:2011	Applicable for Street Light
	IEC 60598-2-5:2015	Applicable for Flood Light
	IEC 60598-1:2014	
	IEC 62471:2006	
	IEC 62471-2:2009	
ENEC	EN 60598-2-3/A1:2011	Applicable for Street Light
	EN 60598-2-5:2015	Applicable for Flood Light
	EN 60598-1: 2015/A1: 2018	
	EN 62471:2008	
SAA	EN 62493:2010	
	AS/NZS 60598.2.3:2015	
ATEX ATEX 95 Equipment Directive(94/9/EC)	AS/NZS 60598.1:2017	
	EN 60079-0:12	
	EN 60079-11:12	
UL	EN 60529:1989+A1:1999	
	UL1598	
	UL8750	
FCC	CSA C22.2 No. 250.0-08	
	CSA C22.2 No. 250.13-14	
PSE	Title 47 CFR Part 15	
	日本電気用品安全法省令別表第八(Safety)	
	日本電気用品安全法省令別表第十(EMC)	

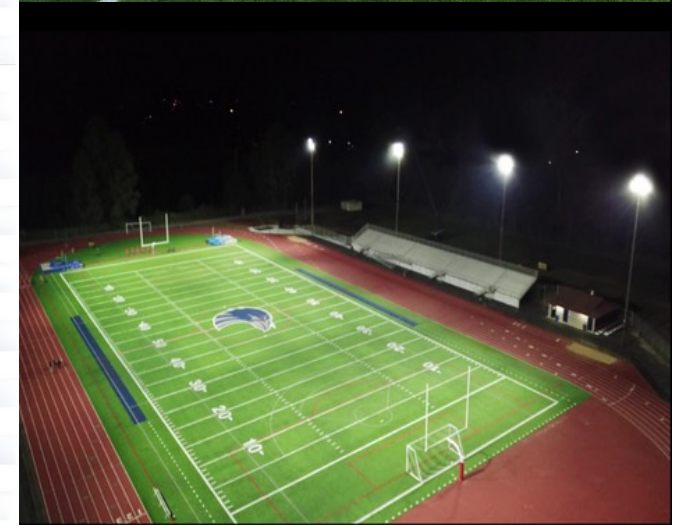

Photobiological Safety	EN 62471:2008 IEC 62471:2006	
Vibration test	ANSI C136.31-2010 IEC/EN 60598-2-5 clause 5.6.7	Applicable for Street Light Applicable for Flood Light
Salt spray test	ISO 9227:2012 ASTM B117	
IK08 Impact resistance test	IEC 62262:2002	
IP65 or IP67 test	IEC/EN 60598-1:2015 clause 9.2.2 and clause 9.2.6 or clause 9.2.8 IES LM-79-2008 ANSI C82.77-2002 ANSI C78.377-2011	
Photometric and Integrating Sphere test	CIE 13.3-1995 CIE 15-2004 IES TM-15-11 IES LM-63-2002	
LED Module	IEC/EN 62031:2008+A1:2013 IES LM-80-2008 ANSI C78.377-2011	
LED Lamps	JESD22 A108 JESD22 A101C JESD22 A105 JESD22 B104 JESD22 A114	
LED Driver	EN 61347-1:2008 EN 61347-2-13:2006 EN 62384:2006+A1:2009 EN 55015:2006+A1:2007+A2:2009 EN 61000-3-2:2006+A1:2009+A2:2009 EN 61000-3-3:2008 EN 61547:2009 IEC 62386 Part 102 and Part 207 UL1012 UL879 UL935 FCC Title 47 CFR Part 15 Class A	Applicable for DALI
Surge Protection Device	ANSI/IEEE C62.41.2-2002 UL1449	
Receptacle	ANSI C136.10-2010	
Dimming Receptacle	ANSI C136.41-2013	

